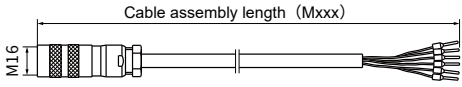
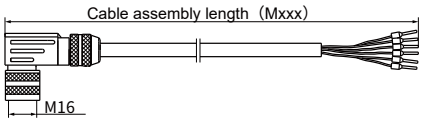
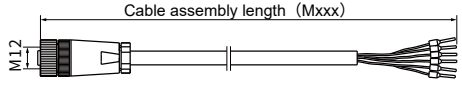
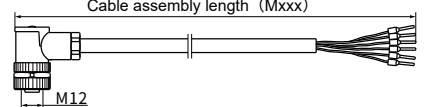
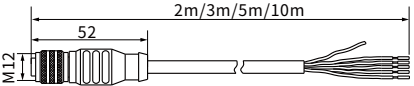
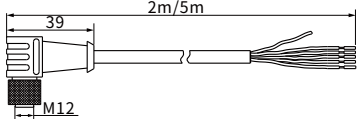

EP Analog Output - Common Options

• Plug assembly cable

Accessory name/model	Dimensions	Description
Analog wiring cable assembly Order No.:AST-Mxxx-H01 (U01)		Mxxx denotes cable length in meters; H01-6-pin PUR orange sheath, temperature-resistant -20~90°C cable assembly; U01-6-pin PVC orange sheath, temperature resistance -20~105°C cable assembly.
Analog wiring right angled cable assembly Order No.:AST-Mxxx-H03 (U03)		Mxxx denotes cable length in meters; H03-6-pin PUR orange sheath, temperature-resistant -20~90°C cable assembly; U03-6-pin PVC orange sheath, temperature resistance -20~105°C cable assembly.
Analog output cable assembly Order No.:AST-Mxxx-W06		Mxxx denotes cable length in meters; W06-5-pin PUR black sheath, temperature -40~80°C cable assembly.
Analog output right angled cable assembly Order No.:AST-Mxxx-W05		Mxxx denotes cable length in meters; W05-5-pin PUR black sheath, temperature -40~80°C cable assembly.

• Finished plug cable

Accessory name/model	Dimensions	Description
M12 5 ngl emale connector Order No. 521801-2 3/5/10 M12 8 ngl emale connector Order No. 521803-5(10)		PUR black sheath, cable core: 1 brown, 2 white, 3 blue, 4 black, 5 gray, temperature resistance -40°C ~-80°C. for No.521801-2 □ 3/5/10□ Wire colour4* for 521803-5(10)
M12 Right angle female connector Order No. 521804-2 5 M12 8 nglangle female connector Order No. 521802-5(10)		PUR black sheath, Cable core:1 brown, 2 white, 3 blue, 4 black, 5 gray, temperature resistance -40°C ~-80°C. Wire colour4* for 521802-5(10)

• Magnet ring/floating ball

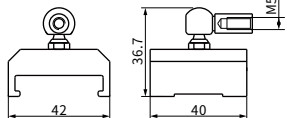
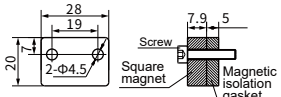
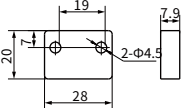
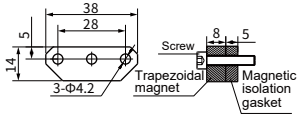
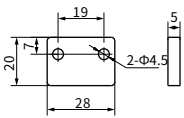
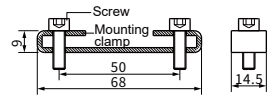
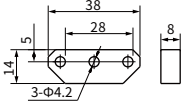
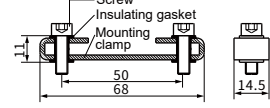
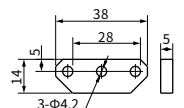
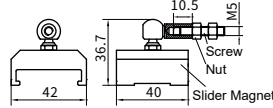
Accessory name/model	Dimensions	Accessory name/model	Dimensions	Description
Slider Magnet Order No.:211517		Square Magnet Order No.:288508		One square magnet 211508, one square magnet gasket 211529 (thickness 5mm), two M4X20 socket screws
Square magnet Order No.:211508		Trapezoidal magnet kit Order No.:288514		One trapezoidal magnet 211514, one trapezoidal magnet gasket 211530 (thickness 5mm), three M4X20 socket screws
Square magnet gasket Order No.:211529		Mounting clamp kit Order No.:211561		One mounting clamp, two M5X16 socket screws
Trapezoidal magnet Order No.:211514		Mounting clamp kit (With insulation) Order No.:211801		One mounting clamp, two M5X16 socket head cap screws, four insulating washers
Trapezoidal magnet gasket Order No.:211530		Slider Magnet Kit Order No.:288517		One slider Magnet 211517~one M5×25Screw~Two M5 Nuts

Note: For other accessories, please refer to general options